

TOSHIBA

OWNER'S MANUAL

LCD Color TV



26WL66A

26WL66E

26WL66T

Owner's Record

You will find the model number and serial number on the back of the TV. Record these numbers in the spaces provided below. Refer to them whenever you call upon your TOSHIBA dealer regarding this product.

Model number:

Serial number:

Contents

Introduction

| | |
|-------------------------------|---|
| Welcome to Toshiba | 3 |
| Important Safety Instructions | 3 |
| Installation | 3 |
| Use | 4 |
| Service | 5 |
| Cleaning | 6 |
| Important information | 6 |

Getting started

| | |
|---|----|
| Connecting an antenna | 7 |
| Exploring your new TV | 7 |
| Installing the remote control batteries | 7 |
| TV top and front panel controls | 8 |
| TV side and back panel connections | 9 |
| Learning about the remote control | 10 |
| Location of controls | 10 |
| Learning about the menu system | 11 |
| Displaying the menu chart | 11 |
| Turning the TV on | 12 |
| Switching on the TV | 12 |
| Switching off the TV | 12 |
| Watching TV programs | 12 |
| Selecting the menu language | 12 |
| Changing the program position | 12 |
| Switching between two program positions | 12 |
| Displaying the on-screen information | 12 |
| Programming channels into the TV's channel memory | 13 |
| Programming channels automatically | 13 |
| Manually setting channels in the channel memory | 13 |
| Setting the program sorting | 14 |

Using the TV's features

| | |
|--|----|
| Picture adjustment | 15 |
| Selecting the picture size | 15 |
| Using the picture still | 16 |
| Adjusting the picture position | 16 |
| Resetting the picture position | 16 |
| Selecting the picture mode | 16 |
| Adjusting the basic picture quality | 16 |
| Activating the black stretch | 17 |
| Activating the MPEG NR (Noise Reduction) | 17 |
| Activating the DNR (Digital Noise Reduction) | 17 |
| Selecting the color temperature | 17 |
| Adjusting the color management | 17 |
| Resetting the base color adjustment | 17 |
| Using the cinema mode | 18 |
| Using the auto format | 18 |
| Sound adjustment | 18 |
| Setting the MTS (Multi-channel TV Sound) | 18 |
| Selecting the dual 1 or dual 2 mode | 18 |
| Selecting the stereo programs | 19 |
| Selecting the bilingual programs | 19 |
| Adjusting the sound quality | 19 |
| Using the SRS WOW surround sound | 19 |
| Using the stable sound | 20 |
| Using the bass boost | 20 |
| Activating blue screen | 20 |
| Other features settings | 20 |
| Selecting the timer menu | 20 |
| Adjusting the brightness of side panel | 20 |

| | |
|--|----|
| Selecting the video input source to view | 21 |
| Setting the manual setting menu | 21 |
| Teletext | 22 |
| Setting up the teletext mode | 22 |
| Teletext general information | 22 |
| Using Auto mode | 22 |
| Using LIST mode | 23 |
| Teletext buttons on the remote control | 23 |

Connecting your TV

| | |
|--|----|
| Side connections | 24 |
| Connection example | 24 |
| Back connections | 24 |
| Connection example | 24 |
| Connecting an HDMI or a DVI device | 25 |
| Connecting an HDMI or a DVI device | 25 |
| Connecting an HDMI device | 25 |
| Connecting a DVI device | 25 |
| Selecting the PC/HDMI audio mode | 26 |
| Setting the HDMI audio mode | 26 |
| Connecting a computer | 26 |
| Using the PC setting | 27 |
| Adjusting the picture size/position | 27 |
| Adjusting the clock phase of the picture | 27 |
| Adjusting the sampling clock | 27 |
| Resetting the PC setting | 27 |

Reference section

| | |
|--|----|
| Troubleshooting | 28 |
| Symptom and solution | 28 |
| Broadcast system | 28 |
| Broadcast transmission systems of each country or region | 28 |
| Specifications | 29 |
| LCD color television | 29 |

Introduction

Welcome to Toshiba

- Thank you for purchasing this Toshiba LCD Color Television. This manual will help you use the exciting features of your new TV.
- Instructions in this manual are based on using the remote control.
- You also can use the controls on the TV if they have the same name as those referred to on the remote control.
- Please read all safety and operating instructions in this manual carefully, and keep this manual for future reference.

Important Safety Instructions

Be sure to observe the following instructions and precautions to ensure safe use of this TV.

Installation

- 1) **Always connect the power plug to an electrical outlet equipped with A model: 220-240V, AC 50Hz, E model: 220-240V, AC 50/60Hz and T model: 110-240V, AC 50/60Hz.**

Never use the TV outside the specified voltage range. It may cause a fire or an electric shock.

WARNING ABOUT THREE-WIRE GROUNDING-TYPE PLUG:

- This product shall be connected to a main socket outlet with a protective earthing connection.
- Never remove the earthing pin on the power plug. This system is equipped with a three pin earthing-type power plug. This plug will only fit an earthing-type power outlet. This is a safety feature. If you are unable to insert the plug into the outlet, contact an electrician to replace the wall outlet.
- Never defeat the purpose of the earthing plug.

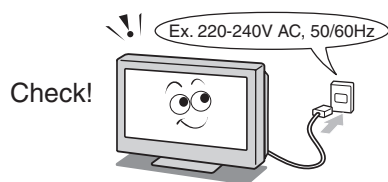

About the fuse

In a three pin earthing-type, the fuse fitted in this plug is approved by ASTA or BSI to BS1362. It should only be replaced by a correctly rated and approved type and the fuse cover must be refitted.

- 2) **Never insert or remove the power plug with wet hands.**

This may cause electric shock.

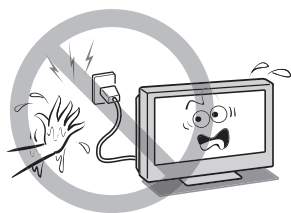

- 3) **Never place the TV in an unstabilized location such as on a shaky table, incline or location subject to vibration.**

The TV may drop or fall down which may cause injury or damage.

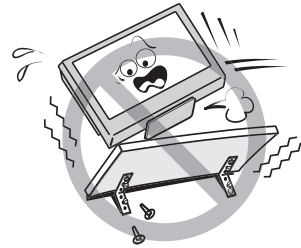

- 4) **Never block or cover the slots and openings in the cabinet.**

- Never place the TV so that it is facing upward or on its side.
- Never place the TV in a closet, bookcase or other similar area where the ventilation is poor.
- Never drape a newspaper, tablecloth or curtain on the TV.
- When installing the TV against a wall, always keep the TV at least 10 cm away from the wall.
- Never place the TV on a soft unstable surface, such as a carpet, or a cushion.

The inside of this TV will overheat if the ventilation holes are covered, blocked or sealed, which may result in a fire.

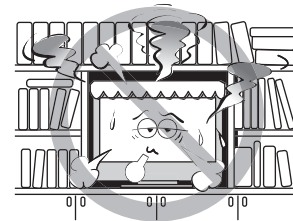

- 5) **Never place the TV near a heater or in direct sunlight.**

The surface of the cabinet or power cord may melt and result in fire or electric shock.



- 6) **Never place the TV in an area exposed to high humidity levels, such as in a bathroom or close to a humidifier.**

This may cause a fire or an electric shock.

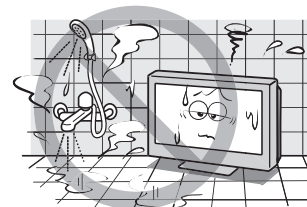

Introduction

- 7) **Never place the TV next to a stove where it will be exposed to oil, smoke, or steam, or in a location where there is a large quantity of dust.**

This may cause a fire or electric shock.



- 8) **Install the TV in a horizontal, stable location. Connect between two clips on the back of the TV and a wall, pillar, etc., with a sturdy tie and clip of supplied accessories (see page 29).**

- Use as short a tie as possible to ensure the TV is stable.
- If the TV is not installed securely, it may lean or fall over and cause an injury.
- To prevent injury, use the exclusive optional stand or wall-hanging bracket to install this TV on the floor or wall securely in accordance with a qualified technician.

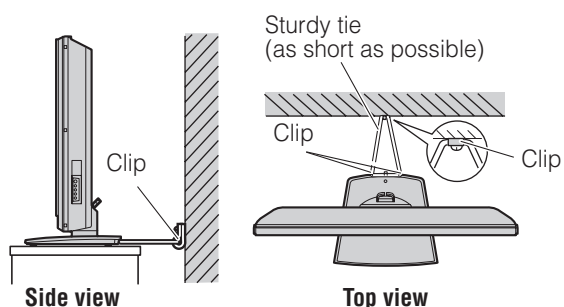

- 9) **Precautions for moving the TV**

- When moving the TV, be sure to remove the plug from the wall outlet and disconnect the antenna cable and audio/video cables, any steady ties. Fire or electric shock may result if the power cord is damaged.
- When carrying the TV, at least two people are needed. Be sure to carry it upright.
- Never carry the TV with the screen facing up or down.

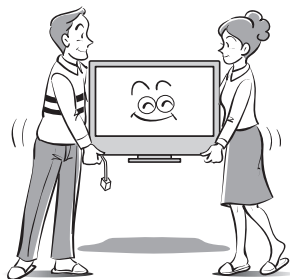

- 10) **Precautions for installing on outdoor antenna**

An outside antenna system should not be located in the vicinity of overhead power lines, or other electric light or power circuits.

If the antenna falls down or drops, it may cause injury or electric shock.

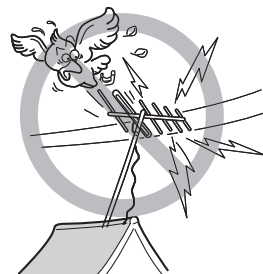

Use

- 1) **Never place hot objects or open flame sources, such as lighted candles or nightlights, on or close to the TV.**

High temperatures can melt plastic and lead to fires.

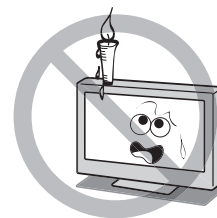

- 2) **The apparatus shall not be exposed to dripping or splashing and that no objects filled with liquids, such as vases, shall be placed on the apparatus.**

When liquids are spilled or small items are dropped inside the TV, this may cause a fire or an electric shock. If small objects drop inside the TV, turn off the TV and remove the power plug from the outlet immediately and contact a service technician.

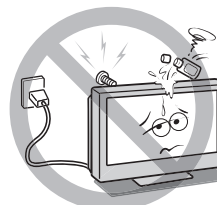

- 3) **Never insert objects (metal or paper) or pour water inside the TV through ventilation holes and other openings.**

These items may cause a fire or an electric shock. If these objects are inserted inside the TV, turn off the TV and remove the power plug from the outlet immediately and contact a service technician. Be especially careful that children do not insert objects in the TV.



Introduction

4) Never stand or climb on the TV.

Be especially careful in households with children to prevent them through climbing on top of the TV. It may move, fall over, break, become damaged or cause an injury.



5) When the TV will not be used for a long period of time, such as during vacation or travel, remove the power plug from the wall outlet for safety.

- The TV is not completely disconnected from the power supply line, as minute current is consumed even when the O/I Power switch is turned off.
- The Mains plug or an appliance coupler is used as the disconnect device, therefore the disconnect device shall remain readily operable.

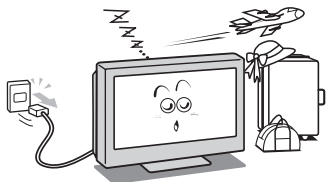

6) Never pull on the power cord when removing the plug from the wall outlet.

Always hold the plug firmly when removing it. If the power cord is yanked, the cord may become damaged and fire or electric shock may occur.



7) Never cut, break, modify, twist, bunch up or bent the cord or apply excessive force or tension to it.

Never place heavy objects on the cord or allow it to overheat as this may cause damage, fire or electric shock. Contact a service technician if the power cord is damaged.

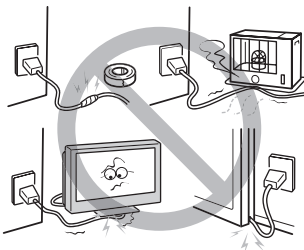

8) If there is thunder or lightning, never touch the antenna cable or other connected cables.

You may suffer an electric shock.

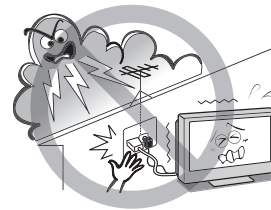

Service

1) Never repair, modify or disassemble the TV by yourself.

It may cause a fire or an electric shock. Consult a service technician for inspection and repairs.



2) When a malfunction occurs, or if smoke or an unusual odor comes from the TV, turn off the TV and remove the power plug from the outlet immediately.

Make sure that the smoke or smell has stopped, then contact a service technician. If the TV is still used in this condition, it may cause a fire or an electric shock.

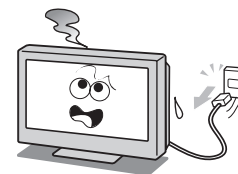

3) If the TV is dropped or the cabinet is broken, turn off the TV and remove the power plug from the outlet immediately.

If the TV is still power used in this condition, it may cause a fire or an electric shock. If the cabinet is broken, be careful when handling the TV to prevent an injury. Contact a service technician for inspection and repair.

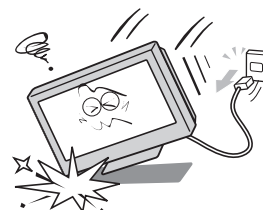

Introduction

- 4) **When the TV reaches the end of its useful life, ask a qualified service technician to properly dispose of the TV.**

Note:

The lamp unit contains a small amount of mercury. Disposal of mercury may be regulated due to environmental considerations. Dispose of the used lamp unit by the approved method for your area. For disposal or recycling information, please contact your local authorities.

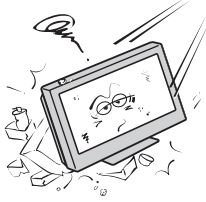

Cleaning

- 1) **Remove the power plug before cleaning.**

Never use solvents such as benzene or thinner to clean the TV.

- These solvents may distort the cabinet or damage its finish.
- If rubber or vinyl products remain in contact with the TV for a long time, a stain may result.

If the cabinet becomes dirty, clean it with a soft, dry cloth.

When cleaning the surface of the LCD display, wipe the panel surface gently with a soft, dry cloth.

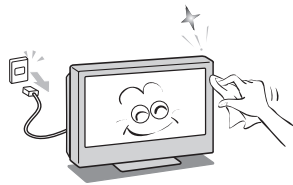

- 2) **Periodically disconnect the power plug from the outlet and check it. If dust has collected on the power plug connectors, clean off the dust.**

This dust may cause a fire due to reduced insulation on the plug.



Important information

- 1) **About LCD screen**

- If you have the LCD screen facing to the sun, the LCD screen will be damaged. Be aware of locating the TV in the place such as window side or outside of the room.
- Never press the LCD screen strongly or scratch it, and never put anything on it. These actions will damage the LCD screen.

- 2) **About cabinet**

Never spray volatile compounds such as insecticide on the cabinet. This may cause a discoloration or damage the cabinet.

- 3) **Some pixels of the screen do not light up**

The LCD display panel is manufactured using an extremely high level of precision technology, however sometimes some pixels of the screen may be missing picture elements or have luminous spots. This is not a sign of a malfunction.

- 4) **About Interference**

The LCD display may cause interference in image, sound, etc. of other electronic equipment that receives electromagnetic waves (e.g. AM radios and video equipment).

- 5) **About using under the low temperature places**

If you use the TV in the room of 0°C or less, the picture brightness may vary until the LCD monitor warms up. This is not a sign of a malfunction.

- 6) **About afterimage**

If a still picture is displayed, an afterimage may remain on the screen, however it will disappear. This is not a sign of malfunction.

Exemptions

- Toshiba is not liable for any damage caused by fires, natural disaster (such as thunder, earthquake, etc.), acts by third parties, accidents, owner's misuse, or uses in other improper conditions.
- Toshiba is not liable for incidental damages (such as profit loss or interruption in business, modification or erasure of record data, etc.) caused by use or inability to use of product.
- Toshiba is not liable for any damage caused by neglect of the instructions described in the owner's manual.
- Toshiba is not liable for any damage caused by misuse or malfunction through simultaneous use of this product and the connected equipment.

Getting started

Connecting an antenna

Optimum reception of color requires a good signal and will generally mean that an outdoor antenna must be used.

The exact type and positioning of the antenna will depend upon your particular area.

Your Toshiba dealer or service personnel can best advise you on which antenna to use in your area.

Before connecting the antenna cable, turn off all main power switches.

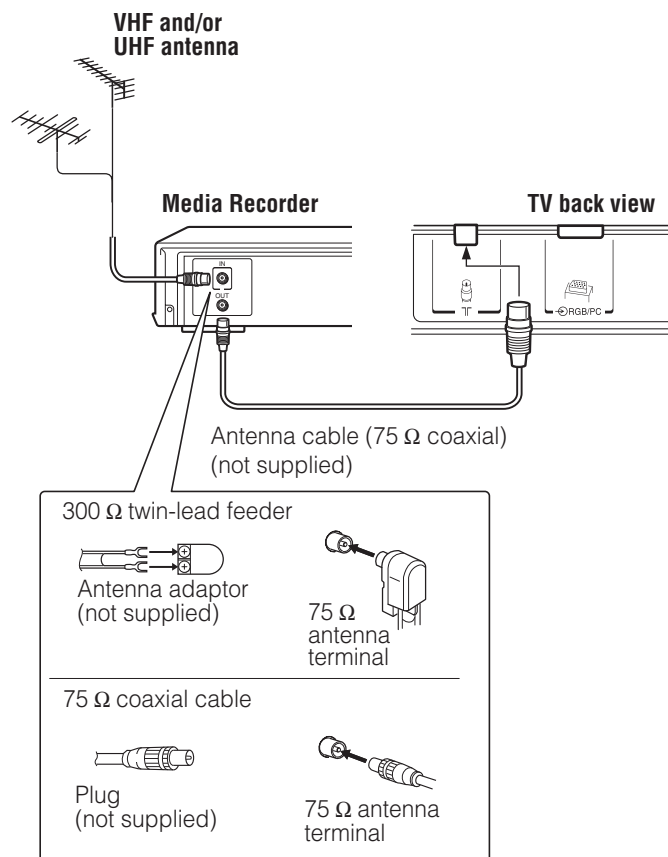

Exploring your new TV

Installing the remote control batteries

Remove the battery cover.

Insert two R03 (AAA) batteries matching the $-/+$ polarities of the battery to the $-/+$ marks inside the battery compartment.

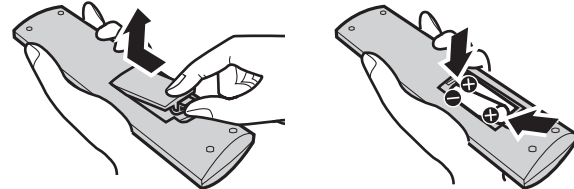

Cautions:

- Dispose of batteries in a designated disposal area. Never throw batteries into a fire.
- Attention should be drawn to the environmental aspects of battery disposal.
- Never mix battery types or combine used batteries with new ones.

Notes:

- If the remote control does not operate correctly, or if the operating range becomes reduced, replace both batteries with new ones.
- If the batteries are dead or if you will not use the remote control for a long time, remove the batteries to prevent battery acid from leaking into the battery compartment.

Effective range

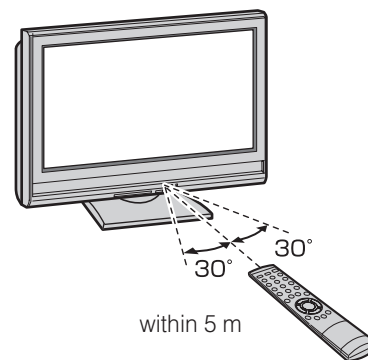

Getting started

TV top and front panel controls

- You can operate your TV using the buttons on the front panel or the remote control. The back and side of the panel provide the terminal connections to connect other equipment to your TV (see “Connecting your TV” pages 24, 25, 26).
- For the use of each control, see the pages in brackets.

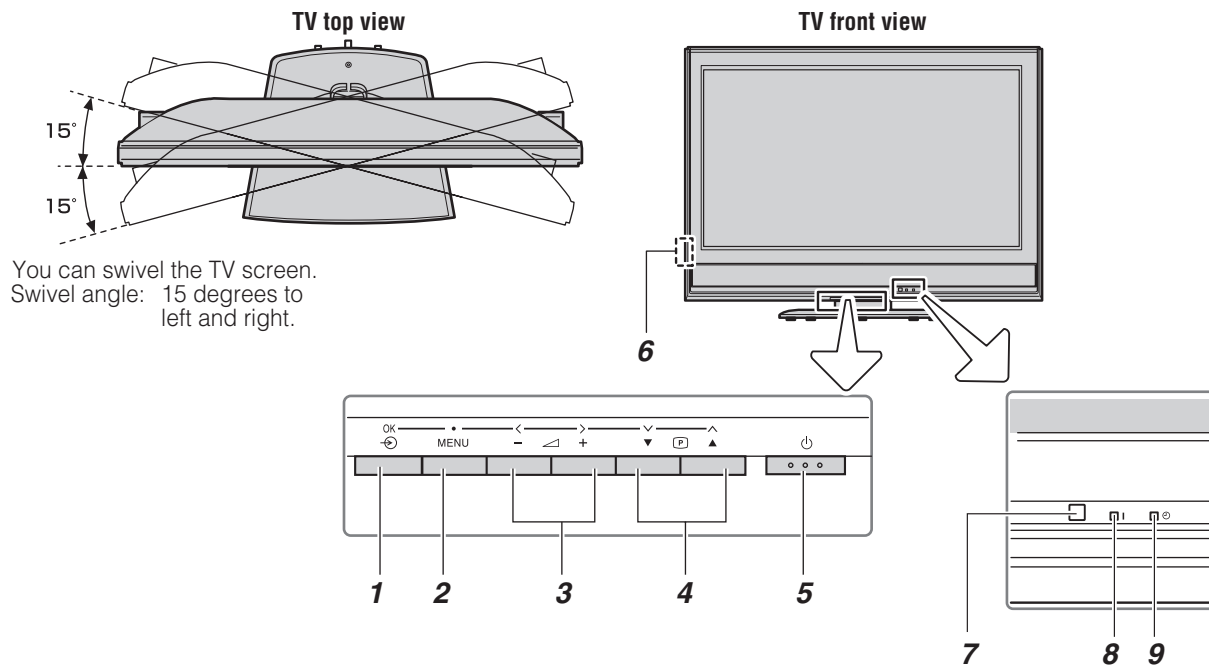

- 1** **(Input source selection)** — When no menu is on-screen, this button selects the input source (see page 21).
OK — When a menu is on-screen, this button functions as the next menu navigation button (see page 11, 21).
- 2** **MENU** — Press to access the menu system (see page 11).
- 3** **- + (Volume)** — When no menu is on-screen, these buttons adjust the volume level (see page 10).
< > (MENU left/right) — When a menu is on-screen, these buttons function as left/right menu navigation buttons or adjust settings (see page 11).
- 4** **▶▲▼ (Program position)** — When no menu is on-screen, these buttons select the program position. (see page 13).
^^ (MENU up/down) — When a menu is on-screen, these buttons function as up/down menu navigation buttons (see page 11).
- 5** **(Power on/Standby)** — Press to turn the TV on/standby (see page 12).
- 6** **(Power switch)** — Press to turn the TV on and off (see page 12).
- 7** **(Remote sensor)** — Point the remote control toward this remote sensor (see page 7).
- 8** **(Power LED)** — Power indicator (see page 12).
- 9** **(Green LED)** — Timer indicator (see page 20).

Getting started

TV side and back panel connections

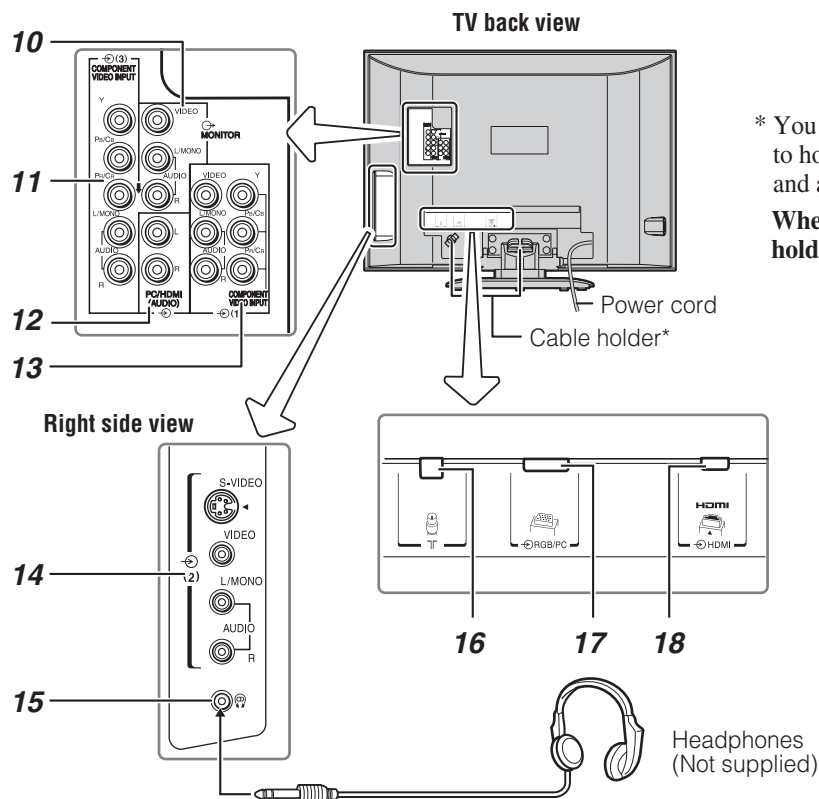

* You can use the cable holder to hold antenna cable, video and audio cables etc.

When moving the TV, never hold this holder.

- 10** **MONITOR (output terminals)** — Standard video and standard audio outputs (see page 24).
- 11** **(3) (Video 3 input terminals)** — High-definition component video and standard audio inputs (see page 24).
- 12** **PC/HDMI (AUDIO) (input terminals)** — For use when connecting a personal computer (PC) or a DVI device with standard audio output (see page 25, 26).
- 13** **(1) (Video 1 input terminals)** — High-definition component video or standard (composite) video and standard (analog) stereo audio inputs (see page 24).
- 14** **(2) (Video 2 input terminals)** — Optional S-video or standard video and standard audio inputs (see page 24).

- 15** **(Headphone jack)** — For use with headphones.

Note:

When the Headphone jack is being used, the sound from all speakers will be muted, and normal sound will be output to the headphones only.

- 16** **(Antenna input terminal)** — Analog antenna signal input (see page 7).
- 17** **RGB/PC (input terminal)** — For use when connecting a personal computer (PC) (see page 26).
- 18** **HDMI (input terminal)** — High-Definition Multimedia Interface input receives digital audio and uncompressed digital video from an HDMI device or uncompressed digital video from a DVI device (see page 25).

Getting started

Learning about the remote control

Location of controls

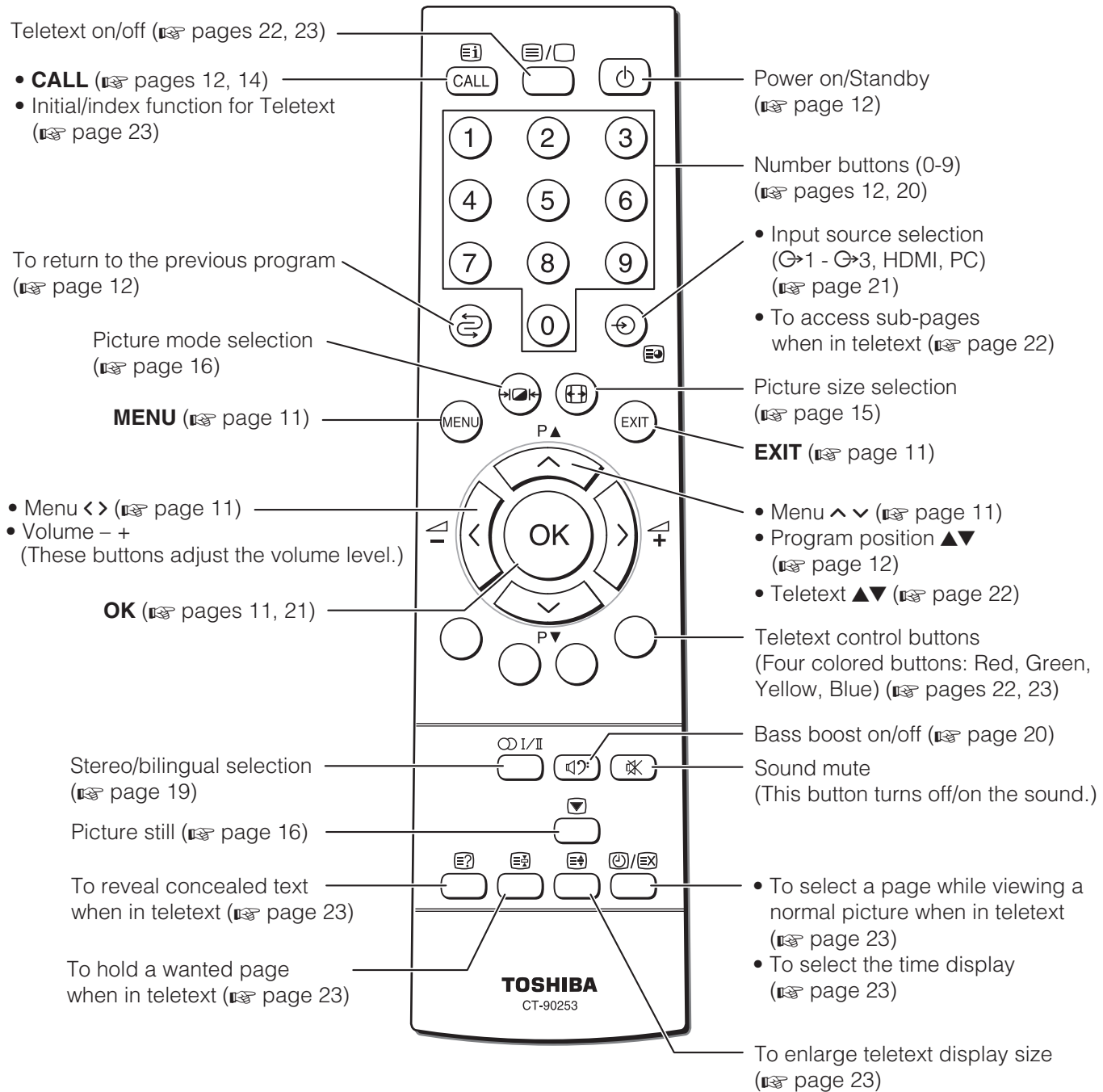

Getting started

Learning about the menu system

We suggest you familiarize yourself with the display charts before using the menu system:

- Press **MENU** to display menu, then press **<** or **>** to select main menu headings.
- Press **∨** or **∧** to select an item.
- Press **<** or **>** to select or adjust setting.
- Press **OK** to display the next menu.

Displaying the menu chart

PICTURE menu

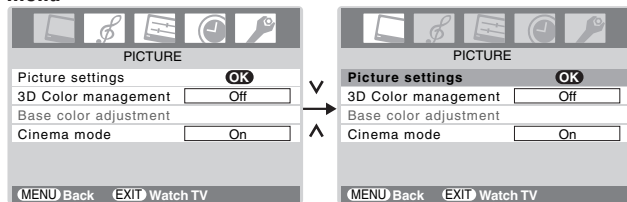

SOUND menu

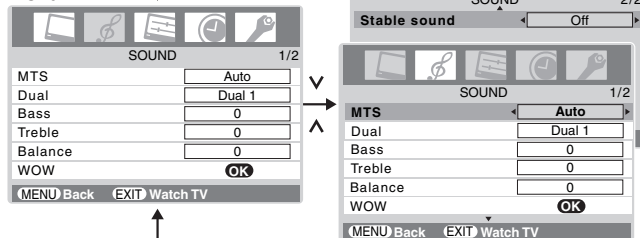

SET UP menu

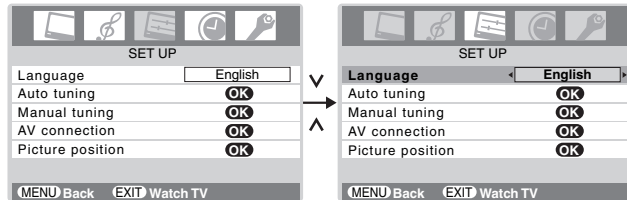

TIMER menu

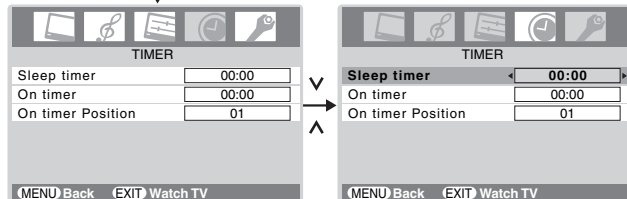

FUNCTION menu

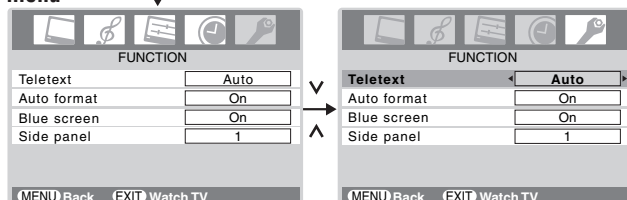

Notes:

- In the video input mode (**1** - **3**), **Auto tuning** and **Manual tuning** are not available. Instead, **Manual setting** appears in the **SET UP** menu (page 21).
- If you connect external equipment via component video source to external input, **Color system** selection in the **Manual setting** menu is not available.
- If you do not make a selection for a while, the menu display disappears automatically.
- If you want to close the menu display instantly, press **EXIT**.
- To return to the previous menu, press **MENU**.
- The **∨** / **∧** function as the Program position **P▲** / **P▼** when there is no menu display on the screen.
- The **<** / **>** function as the Volume **∠+** / **∠-** when there is no menu display on the screen.
- In the PC input mode, **PC Setting** appears in the **SET UP** menu (page 27).
- In the 480i or 576i input signals mode, you can select the **Cinema mode** in the **PICTURE** menu (page 18).
- When you use the color management function (page 17), you can select the **Base color adjustment** in the **PICTURE** menu.

Getting started



Turning the TV on

Switching on the TV

Connect the power cord to a wall outlet.

- 1 Press  on the TV left side until it clicks.





The | Power indicator lights in red. Press  on the remote control or  on the TV front panel if no picture appears.

Note:

If you watch black and white programs when the color system mode is set to Auto, color noise may appear on the screen. In this case select the appropriate Color system (For the system of each country or region, refer to pages 13 and 28).

Switching off the TV

- 1 Press  on the remote control or  on the TV front panel to switch to the standby mode.
- 2 To switch the TV off, press  on the TV left side. Power indicator will be turned off.



Notes:

- This TV is not fully disconnected from the main supply, as minute current is consumed even when  is turned off. When the TV will not be used for a long period of time, such as during vacation or travel, remove the power plug from the wall outlet.
- The TV will automatically turn itself off after approximately 15 minutes if it is tuned to a vacant channel or a station that completes its broadcast for the day. This function does not work in external input or Blue screen Off mode. The TV will automatically turn itself off after approximately 2 hours if you do not operate the TV after turned on by on timer function.
- If power is cut off while you are viewing the TV, the Last Mode Memory function turns on the TV automatically when power is applied again. If power is going to be off for a long time and you are going to be away from your TV, unplug the power cord to prevent the TV from turning on in your absence.

Watching TV programs

Selecting the menu language

Choose from 9 different languages (English, Chinese (CS), Malay, Thai, Vietnamese, Russian, Arabic, Persian or French) for the on-screen display.

- 1 Press , then press < or > to display **SET UP** menu.
- 2 Press  or  to select **Language**.

- 3 Press < or > to select the desired language.

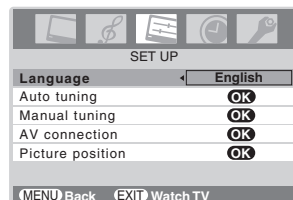

Changing the program position

- 1 Enter the desired program position number using the **Number** buttons on the remote control. For program positions below 10, use 0 and the required number e.g., for program position 1.
- 2 You can also change the program position by using **P▲** or **P▼**. The program position will be displayed on the screen with the Mono/Stereo/Dual audio status.

Note:

The program position selection change between different format channels takes several seconds.

Switching between two program positions

You can switch two program positions without entering actual position number each time.

- 1 Select the first program position you want to view.
- 2 Select the second program position with the **Number** buttons (0-9).
- 3 Press . The previous channel will be displayed.

Each time you press , the TV will switch back and forth between the two program positions.

Displaying the on-screen information

- 1 Press  to display the following on-screen information.



The information will disappear in 6 seconds.

- Program position or external input mode selected
 - Program skip on/off information
 - Label (if set)
 - Mono/Stereo/Dual audio status
- 2 To erase the display instantly, press  again.

Getting started

Programming channels into the TV's channel memory

- First, use the Auto tuning function to preset all the active channels in your area automatically. Then, arrange the preset channels with the Manual tuning function so that you can tune into only desired channels.
- Use the Manual tuning operation if desired channels cannot be preset with the Auto tuning or if you would like to preset channels to specific position numbers one by one.

Programming channels automatically

- 1 Press **MENU**, then press **<** or **>** to display the **SET UP** menu.
- 2 Press **∨** or **∧** to select **Auto tuning**.

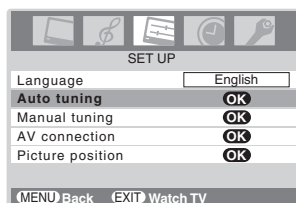

- 3 Press **OK** to display the **Auto tuning** menu.

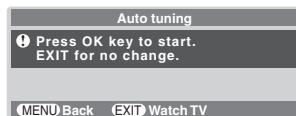

- 4 Press **OK** to start the automatic search. The search will begin for all available stations.

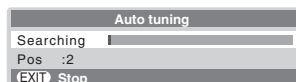

The slide bar will move along the line as the search progresses.

If you make a mistake, simply repeat steps 1-4 to start again from the beginning.

- 5 When the automatic search is completed, the TV will automatically return to the first program position.
- 6 Press **P▲** or **P▼** to view the programmed position.

Note:

When you preset the program channel which sound of broadcast transmission system adopts "M" system, the sound system may not be tuned correctly if the radio waves transmit badly. At that time, preset the channel by **Manual tuning**. The countries such as Myanmar, Brazil, Chile, Colombia apply to this case. See page 28 for more details.

Manually setting channels in the channel memory

- 1 From the **SET UP** menu, press **∨** or **∧** to select **Manual tuning**.
- 2 Press **OK** to display the **Manual tuning** menu. Press **∨** or **∧** to select the program position you want to arrange.

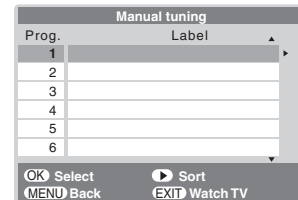

- 3 Press **OK** to display the breakdown menu. Press **<** or **>** to select an item, then press **∨** or **∧** to select the item as shown below.

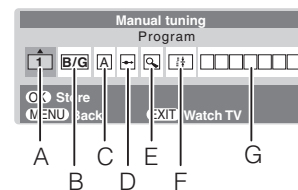

- A. Program position selection
- B. Sound system (see page 28)
- C. Color system (see page 28)
 - A** : Automatic (factory set), **P** : PAL, **S** : SECAM
 - N4** : NTSC 4.43 (MHz), **N3** : NTSC 3.58 (MHz)

If the color of a certain channel is abnormal, the automatic color system selection (A) may have malfunctioned, or sound system selection is wrong. In such a case, select another color and/or sound system (see page 28).
- D. Program position skip selection

Press **∨** or **∧** to turn the program position skip option on "↔" or off "→".

The program position will then be skipped when you select channels with **P▲** or **P▼**.

The "↔" mark will appear beside a program position number when you use the **Number** button on the remote control.
- E. Channel search operation

Press **∧** to search up the band or **∨** to search down the band.

Press **∨** or **∧** repeatedly until your desired channel is displayed.

When a station/satellite is found, it will be displayed. NEVER PRESS ANY OTHER BUTTONS WHILE THE SET IS TUNING.
- F. Auto Fine Tuning

Press **∨** or **∧** to turn the Auto Fine Tuning option on "≡" or off "0".

The Auto Fine Tuning function automatically corrects slight fluctuations when receiving signals.

Manual Fine Tuning

While the Auto Fine Tuning turn off "0", press **∨** or **∧** so that the better picture and sound are obtained.

(continued)

Getting started

G. Label

Station labels appear under the program position display each time you turn on the TV, select a channel, or press **CALL**.

To change or create station labels:

- 1) Press **∇** or **▲** repeatedly to select a character for the first space, then press **▶**.

→A←Z←(←)←*←+←,←-←./←0←9←□←*

*(blank space)

- 2) Repeat step 1) to enter the rest of the characters. If you would like a blank space in the label name, you must choose a blank space from the list of characters.

Press **OK** to store your settings.

Setting the program sorting

- The TV is capable of receiving a number of different channels depending upon where you live.
- Program sorting is an easy way of storing each channel on the program position of your choice.

Ex.: To swap channel ABCD (Prog.1) for channel MNOP (Prog.4):

- 1 Press **MENU**, then press **◀** or **▶** to display the **SET UP** menu.

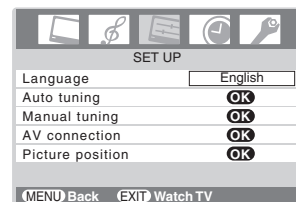

- 2 Press **∇** or **▲** to select **Manual tuning** menu, then press **OK**.

- 3 Press **∇** or **▲** to select the channel **ABCD**, then press **▶**.

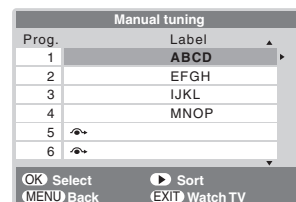

- 4 Press **∇** to select the new position **“4”**, then press **◀**.

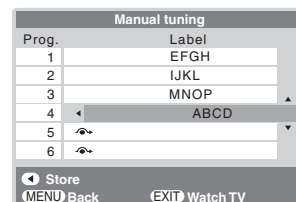

- 5 Press **▲** to select the channel **MNOP**, then press **▶**.

- 6 Press **▲** to select the new position **“1”**, then press **◀**.

- 7 Confirm new **Manual tuning** menu.

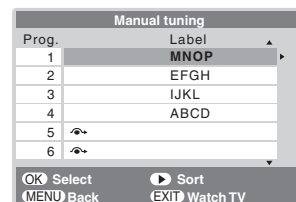

Using the TV's features

Picture adjustment

Selecting the picture size

- 1 Press and hold **(F)** until the picture size list appears on the screen, then press **▼** or **▲** to select the appropriate picture size (or press **(F)** repeatedly to select required picture size directly).

The antenna input signal

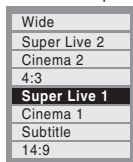

- 2 Press **(OK)**.

Super Live 1

When receiving "4:3 format" signal, this setting will enlarge the image to fit the screen by stretching the image vertically and horizontally, holding the better proportions at the center of the image.

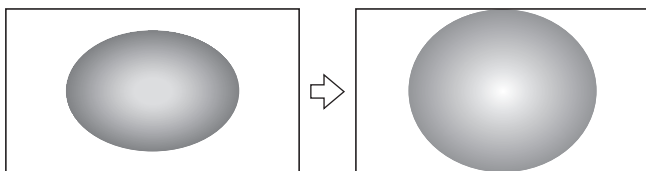

Cinema 1

When watching "letterbox format" films/video tapes, this setting will eliminate or reduce the black bars at the top and bottom of the screen by zooming in and selecting the image without distortion.

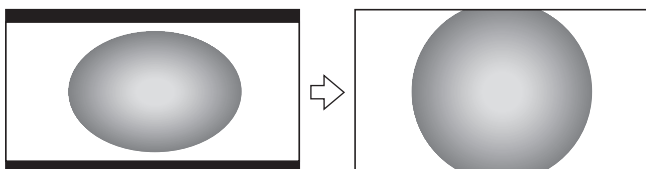

Subtitle

When subtitles are included on a letterbox format broadcast, this setting will raise the picture so that the most of text is displayed.

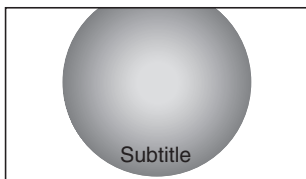

14:9

Use this setting when watching a 14:9 broadcast.

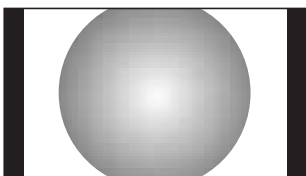

Wide

Use this setting when watching a wide-screen DVD, wide-screen video tape or a 16:9 broadcast (when available). Due to the range of wide-screen formats (16:9, 14:9, 20:9 etc.), you may see bars on the top and bottom of the screen.

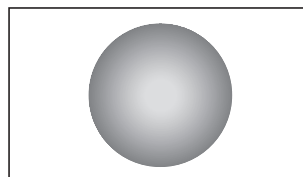

Super Live 2

When receiving "side panel format" signal, this setting will enlarge the image to fit the screen by stretching the image vertically and horizontally, holding the better proportions at the center of the image. Also the black bars on the both sides of the screen will eliminate or reduce.

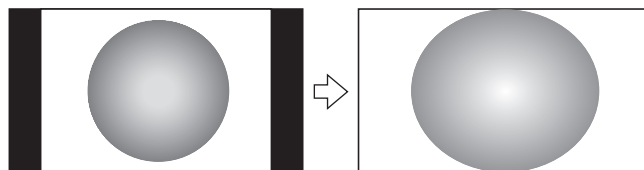

Cinema 2

When watching "all sides panel format" films/video tapes, this setting will eliminate or reduce the black bars on all the sides of the screen by zooming in and selecting the image without distortion.

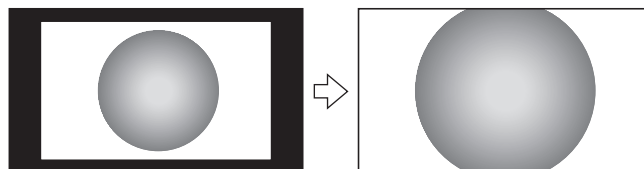

4:3

Use this setting to view a true 4:3 broadcast.

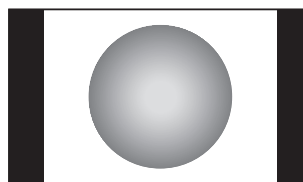

Notes:

- Using the special functions to change the size of the displayed image (e.g. changing the height/width ratio) for the purpose of public display or commercial gain may infringe on copyright laws.
- If the aspect ratio of the selected format is different from the one of the TV transmission or video program, it can cause a difference in vision. Change to the correct aspect ratio picture size.
- In the PC input mode (see page 21), the picture size selection is wide or normal only.
- In the 1080i or 720p input signal mode, the picture size selections are **Super Live 1**, **Cinema 1**, **Wide**, **Super Live 2**, **Cinema 2** and **4:3**.

Using the TV's features

Using the picture still

- Press  to freeze the picture.

Even if an image is frozen on the TV screen, the pictures are running on the input source. Audio continues to be output as well.

To return to a moving picture, press  again.

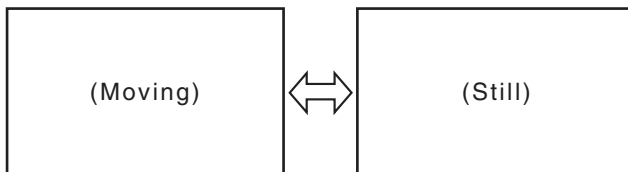



Notes:



- If you use this function except for the purpose of your private viewing and listening, it may infringe the copyright protected by the copyright laws.
- In the PC input mode (see page 21), this function is not available.

Adjusting the picture position

Adjustment to the position of the picture may be made to suit your viewing preferences.

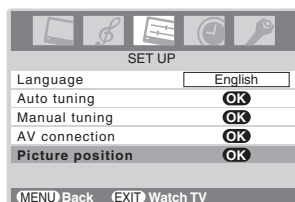
- Press , then press < or > to display the **SET UP** menu.
- Press the  or  to select **Picture position**.



- Press , then press  or  to select an item you want to adjust.

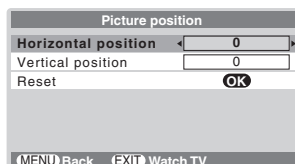

- Press < or > to adjust the settings as required.





Note:

When the picture format is in Wide or 4:3 mode, only the Horizontal position can be adjusted.

Resetting the picture position

This function resets your picture position settings to the factory settings.





- From the **Picture position** menu, press  or  to select **Reset**.
- Press .

Selecting the picture mode

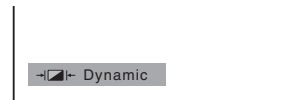
You can select the picture quality instantly among three preset modes and one user-set mode.

- Press  to select the desired picture quality.



| Mode | Picture quality |
|---|-----------------------------|
|  Dynamic | bright and dynamic picture |
|  Standard | standard picture |
|  Mild | soft picture |
|  Memory | the picture quality you set |

Note:

In the PC input mode (see page 21), this mode is not available.

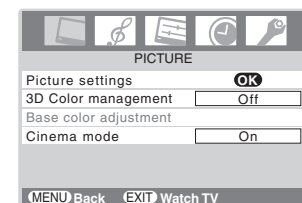

Adjusting the basic picture quality

- Press , then press < or > to display the **PICTURE** menu.

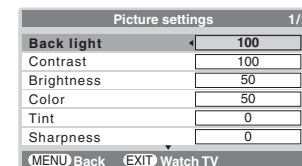

- Press  or  to select the **Picture settings** menu, then press .



- Press  or  to select an item you want to adjust, then press < or > to adjust the settings as required.



| Selection | < Pressing > |
|------------|------------------|
| Back light | darker lighter |
| Contrast | lower higher |
| Brightness | darker lighter |
| Color | paler deeper |
| Tint | reddish greenish |
| Sharpness | softer sharper |

Notes:

- The **Tint** may only be adjusted on a tape which has been recorded and played back on an NTSC VCR.
- In the PC input mode (see page 21), **Color**, **Tint** and **Sharpness** modes are not available.

Using the TV's features

Activating the black stretch

This function increases the strength of dark areas of the picture which improves definition.

- 1 From the **Picture settings** menu, press ∇ or \blacktriangle to select **Black stretch** on the 2nd page.

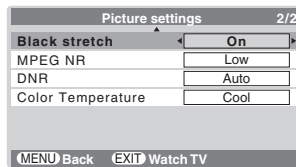

- 2 Press \leftarrow or \rightarrow to select **On** or **Off**.



Note:

In the PC input mode (page 21), this mode is not available.

Activating the MPEG NR (Noise Reduction)

If the receiving signal of MPEG is a mosquito (grained) noise depending on the compression and conversion, the noise may be reduced when using this function.

- 1 From the **Picture settings** menu, press ∇ or \blacktriangle to select **MPEG NR** on the 2nd page.
- 2 Press \leftarrow or \rightarrow to select **Off**, **Low**, **Middle** or **High**.



Note:

In the PC input mode (page 21), this mode is not available.

Activating the DNR (Digital Noise Reduction)

If the receiving signal is weak and the picture is blurry, the picture may be improved when using this function.

- 1 From the **Picture settings** menu, press ∇ or \blacktriangle to select **DNR** on the 2nd page.
- 2 Press \leftarrow or \rightarrow to select **Auto**, **Off**, **Low**, **Middle** or **High**.



Note:

This function is available for 480i and 576i signals.

Selecting the color temperature

You can change the tone of the picture by selecting from three preset color temperatures: **Cool**, **Normal** or **Warm**.

- 1 From the **Picture settings** menu, press ∇ or \blacktriangle to select **Color Temperature** on the 2nd page.
- 2 Press \leftarrow or \rightarrow to select mode you prefer.



Cool: Lends a blue hue to the picture.

Normal: Neutral

Warm: Lends a red hue to the picture.

Adjusting the color management

You can adjust the picture color quality by selecting from 6 base color adjustments : **Red**, **Green**, **Blue**, **Yellow**, **Magenta** or **Cyan**.

- 1 Press MENU , then press \leftarrow or \rightarrow to display the **PICTURE** menu.
- 2 Press ∇ or \blacktriangle to select **3D Color management**, then press \leftarrow or \rightarrow , then press \leftarrow or \rightarrow to select **On**.

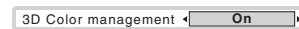

- 3 Press OK , then press ∇ or \blacktriangle to select **Base color adjustment**.
- 4 Press OK , then press ∇ or \blacktriangle to select an item you want to adjust.
- 5 Press \rightarrow , then press \leftarrow or \rightarrow to select **Hue**, **Saturation** or **Brightness**.

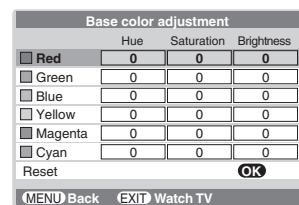

- 6 Press ∇ or \blacktriangle to adjust the settings as required.

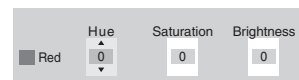

Notes:

- If you select color management **Off** mode, this mode is not available.
- In the PC input mode (page 21), this mode is not available.

Resetting the base color adjustment

The Reset function adjusts the base color adjustment to the factory settings.

- 1 From the **Base color adjustment** menu, press ∇ or \blacktriangle to select **Reset**.
- 2 Press OK .

Using the TV's features

Using the cinema mode

A movie film's picture runs at 24 frames a second, whereas movie software such as DVD, etc., that you enjoy watching on television at home runs at 30 (NTSC) or 25 (PAL) frames a second. To convert this signal to reproduce a smooth motion and picture quality, select the **On** mode.

Effective signal and setup conditions:

- When the Video input mode is selected.
- When the input signal format is 480i and 576i signals.

1 Press **MENU**, then press **<** or **>** to display the **PICTURE** menu.

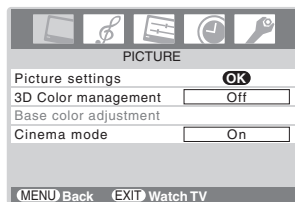

2 Press **∨** or **∧** to select **Cinema mode**, then press **<** or **>** to select **On** or **Off**.

Note:

When a DVD movie with subtitle is playing back, this mode may not work correctly.

Using the auto format

When the TV receives a true HDMI signal picture and the auto format is On, it will automatically be displayed in HDMI signal format, irrespective of the TV's previous setting.

1 Press **MENU**, then press **<** or **>** to display the **FUNCTION** menu.

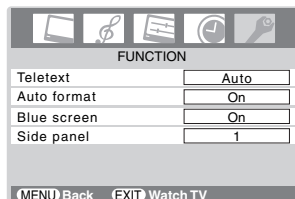

2 Press **∨** or **∧** to select **Auto format**, then press **<** or **>** to select **On** or **Off**.

Sound adjustment

Setting the MTS (Multi-channel TV Sound)

Auto mode

The MTS Auto mode automatically recognize stereo/bilingual programs depending on the broadcast signal.

1 Press **MENU**, then press **<** or **>** to display the **SOUND** menu.

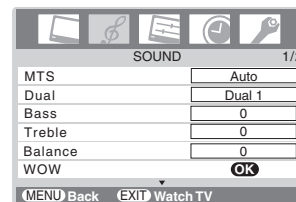

2 Press **∨** or **∧** to select **MTS**, then press **<** or **>** to select **Auto** or **Mono**.

Mono mode

If you experience noise or poor reception of any stereo/bilingual program, set the **MTS** mode to **Mono**. Noise will be reduced and reception may improve.

Note:

If you experience noise with a particular program on whose channel reception is usually good, try setting MTS mode to **Auto**, then switch **COIN** to **□ Mono (monaural)** (page 19).

Selecting the dual 1 or dual 2 mode

You can hear only dual 1 or dual 2 sound selected, whenever bilingual programs are received.

1 Press **MENU**, then press **<** or **>** to display the **SOUND** menu.





2 Press **∨** or **∧** to select **Dual**, then press **<** or **>** to select **Dual 1** or **Dual 2**.

Notes:

- When the MTS setting is in **Mono** mode, the **Dual** menu is not selectable.
- The **Dual** menu setting status remains even if the TV is turned off.



Using the TV's features

Selecting the stereo programs

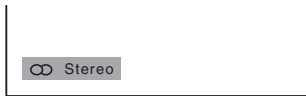

- 1 When a stereo program is received,  **Stereo** appears.
- 2 Press  to select the stereo/monaural mode.  **Stereo** and  **Mono** appear cyclically on the screen.



Selecting the bilingual programs

- 1 When a bilingual program is received,  **Dual** appears.
- 2 Press  to select the sound to be heard. The sound differs according to the transmission system: NICAM or German stereo/bilingual broadcast.



| Display | Sound to be heard | |
|---|-------------------|---------------------------------------|
| | NICAM | German stereo/ bilingual broadcast |
|  Dual 1 | Sub I sound | Main sound |
|  Dual 2 | Sub II sound | Sub sound |
|  Mono | Main sound | — |

Note:

These settings are not stored in the TV memory.

Adjusting the sound quality

- 1 From the **SOUND** menu, press \downarrow or \uparrow to select an item you want to adjust.
- 2 Press \leftarrow or \rightarrow to adjust the settings as required.



| Selection | \leftarrow | Pressing | \rightarrow |
|-----------|--------------|-----------------------------|----------------------------|
| Bass | weaker | | stronger |
| Treble | weaker | | stronger |
| Balance | | decreases the right channel | decreases the left channel |

Using the SRS WOW surround sound

SRS WOW is a special combination of SRS Labs audio technologies that creates a thrilling surround sound experience with deep, rich bass from stereo sound sources. Your TV's audio will sound fuller, richer and wider.

WOW consists of three features; SRS 3D, FOCUS, and TruBass, being turned on.

- 1 From the **SOUND** menu, press \downarrow or \uparrow to select **WOW**, then press .

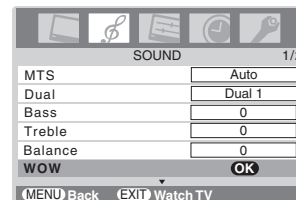

- 2 Press \downarrow or \uparrow to select an item you want to adjust, then press \leftarrow or \rightarrow to adjust the settings as required.

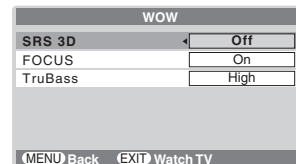

SRS 3D: To turn the surround effect **On** or **Off**.

FOCUS: To turn the vocal emphasis effect **On** or **Off**.

TruBass: To select the desired bass expansion level (**Off**, **Low** or **High**).

Notes:

- If the broadcast is monaural, the SRS 3D effect does not work.
- WOW, SRS and  symbol are trademarks of SRS Labs, Inc.
- WOW technology is incorporated under license from SRS Labs, Inc.
- The SRS WOW effect is active only when the sound outputs from the speaker.

Using the TV's features

Using the stable sound

The Stable sound function limits the highest volume level to prevent extreme changes in volume when the signal source changes (for example, to prevent the sudden increase in volume that often happens when a TV program switches to a commercial).

- 1 Press **MENU**, then press **<** or **>** to display the **SOUND** menu.
- 2 Press **∨** or **∧** to select **Stable sound** on the 2nd page.



- 3 Press **<** or **>** to select **On** or **Off**.

Note:

The Stable sound effect is active only when the sound outputs from the speaker.

Using the bass boost

- 1 Press **EQ** to display **Bass boost** level.



- 2 While the **Bass boost** display is on the screen, press **<** or **>** to adjust the Bass boost level.
- 3 To turn off the Bass boost, press **EQ** to display **Bass boost Off**.



Note:

The Bass boost effect is active only when the sound outputs from the speaker.

Activating blue screen

With the blue screen function **On**, the screen will automatically turn blue and the sound will be muted when no signal is being received.

- 1 Press **MENU**, then press **<** or **>** to display the **FUNCTION** menu.
- 2 Press **∨** or **∧** to select **Blue screen**.

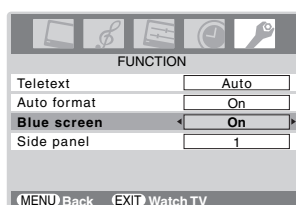

- 3 Press **<** or **>** to select **On** or **Off**.

Note:

In the PC input mode (see page 21), this function is not available.

Other features settings

Selecting the timer menu

The Timer is especially useful if you want the TV to turn itself on or off after a selected period of time.

- 1 Press **MENU**, then press **<** or **>** to display the **TIMER** menu.

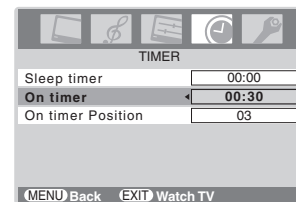

- 2 Press **∨** or **∧** to select the required timer mode (**Sleep timer** (Turn off the TV) or **On timer**). The timer display will set by 10 minutes, up to 12 hours and 50 minutes.
- 3 Press the **Number** buttons (0-9), **<** or **>** to set the On or Off delay time, e.g. on in 30 minutes and On timer Position 3 selected.
- 4 Press **EXIT** to exit the menu. When setting the On timer, press **∨** or **∧** to select the **On timer Position** and enter the program position number you want to watch. Set the Standby mode by pressing **Power** on the remote control or **Power** on the TV. Activation of the Timer is indicated by the green "On-timer indicator", on the front of the TV (see page 8).

Notes:

- The TV will automatically turn itself off after approximately 2 hours if you do not operate the TV after turned on by on timer function.
- If you press and hold **<** or **>** to set the On or Off delay time, the timer display will set by 30 minutes, up to 12 hours 30 minutes.

Adjusting the brightness of side panel

You can adjust the brightness of side panel in 14:9 or 4:3, etc. mode.

- 1 From the **FUNCTION** menu, press **∨** or **∧** to select **Side panel**.
- 2 Press **<** or **>** to adjust the settings as required.



Using the TV's features

Selecting the video input source to view

- 1 Press and hold or press on the remote control until the video input mode list appears on the screen, then press or to select appropriate input source (or press on the TV front panel or on the remote control repeatedly to select required input source directly).

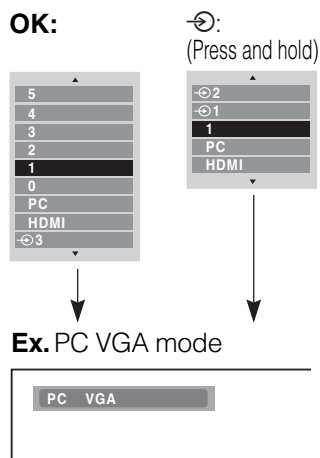

- 2 Press .
 1 ((1), video 1 input) or 1C (component video input),
 2 ((2), video 2 input) or 2S (S-video input),
 3 ((3), component video input),
HDMI (HDMI, HDMI input),
PC (RGB/PC, PC input)

Note:

When the component video input, PC input mode or HDMI input mode is selected, the **MONITOR OUT** output terminals (page 24) output audio signal only.

Setting the manual setting menu

- 1 Press , then press or to display the **SET UP** menu.

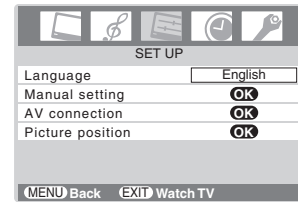

- 2 Press or to select **Manual setting**, then press .
- 3 Press or to select an item, then press or to select the item as shown below.

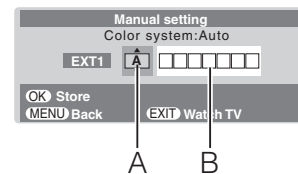

A. Color System

Confirm that color system is set to “**A**” (Auto). If not, select “**A**” with or .

B. Video label

The video label allows you to label each input source for your TV.

To change or create video labels:

- 1) Press or repeatedly to select a character for the first space, then press .

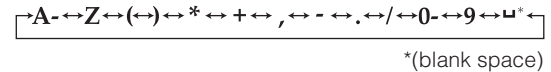

*(blank space)

- 2) Repeat step 1) to enter the rest of the characters.
If you would like a blank space in the label name, you must choose a blank space from the list of characters.
- 3) Press to store your settings.

Using the TV's features

Teletext

This TV has a multi-page teletext memory, which takes a few moments to load and it offers two ways of viewing Teletext **Auto** and **LIST** which are explained below.

Setting up the teletext mode

To select teletext mode:

Select a channel position with the desired teletext service.

- 1 Press **MENU**, then press **<** or **>** to display the **FUNCTION** menu.

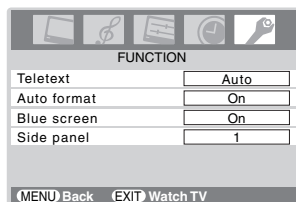

- 2 Press **∇** or **∧** to select **Teletext**, then press **<** or **>** to select **Auto** or **LIST** mode.

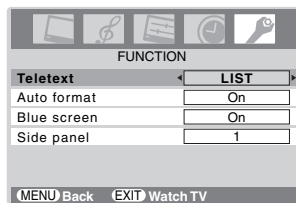

Note:

When you are watching the teletext program, **SET UP** menu and **FUNCTION** menu are not selectable.

Teletext general information

≡/□ button:

Pressing **≡/□** once will bring up the teletext screen. Press again to superimpose the teletext over a normal broadcast picture. Press again to return to normal TV mode. You need to return to normal viewing if you wish to change channels.

When you first press **≡/□** to access the text service, the first page you see will be the initial page.

In **Auto** mode, this displays the main subjects available and their relevant page numbers.

In **LIST** mode, you will see the page numbers currently stored on the **each color** button.

Sub-pages:

Once in this chosen page, if there are sub-pages they will automatically load into memory without changing the one you are reading. If there are many sub-pages, it will take a long time for them all to load and this will depend on the speed with which the broadcaster transmits them.

To access the sub-pages in memory, press **⇒**, then use **∇** and **∧** to view them.

Note:

If you press **∇** while the picture mode is activated, this mode will be cancelled.

Using Auto mode

There are two Modes: **Auto** will display FASTEXT, if available. **LIST** will display your four favorite pages. In either mode, as an alternative to the colored buttons, you can access a page by entering a 3-digit number, using the **Number** buttons on the remote control, or to advance to the next page, press **P▲**, to go back to the previous page press **P▼**.

To change between **Auto** and **LIST**, see above.

- Press **≡/□** to access teletext.

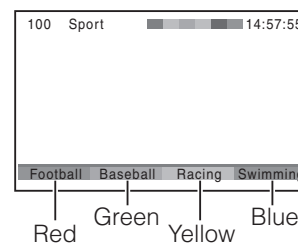



If FASTEXT is available, you will see 4 colored titles at the base of the TV screen. To access any given subject, simply press the relevant colored button on the remote control.

If FASTEXT is not available, you can access any page simply by entering a 3-digit page number or pressing the corresponding colored button.

For further information on your particular text system(s), see the broadcast teletext index page or consult your local Toshiba dealer.

Using the TV's features

Using LIST mode

- 1 Press / to access teletext.

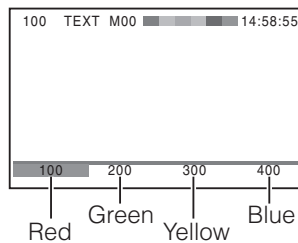

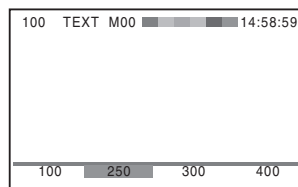

The four choices at the bottom of the screen are now number – **100, 200, 300** and **400**, which have been programmed into the TV's memory.

- 2 To view these pages, use the colored prompt buttons. e.g. press the Green button to view page 200.
- 3 If you want to change these stored pages, press the colored button for the color you want to change. e.g. Press the Green button and enter the 3-digit number.





This number will change in the top left of the screen and in the colored highlight.

- 4 Press  to store your choice. The bars at the bottom of the screen will flash white.
- 5 You may view other pages by simply entering the 3-digit page number – but NEVER press  or you will lose the favorite already stored.

Teletext buttons on the remote control

Below is an introduction to the teletext buttons on your remote control and their functions.

/ To display a page of teletext:

Press / to display teletext. Press again to superimpose the teletext over a normal broadcast picture. Press again to return to normal TV mode.

To display an index/initial page:

In Auto-mode

Press  to access the index page. The one displayed is dependant on the broadcaster.

In LIST-mode

Press  to return to the 100 page or initial page.

To reveal concealed text:

Some pages cover topics such as quizzes and jokes. To discover the solutions, press .





To hold a wanted page:

This function is included as it is part of the broadcast teletext system but you will not need it as this TV allows you to control the display of sub-pages.



To enlarge the teletext display size:

Press  once to enlarge the top half of the page, press again to enlarge the bottom half of the page. Press again to revert to the normal size.



/ To select a page while viewing a normal picture:

When in teletext mode, if a page selection is made and then / is pressed, a normal picture will be displayed. The TV will indicate when the page is present by displaying the title bar of the text page at the top of the screen. Press / to view the page.

Note:

It will not be possible to change program position while in Teletext mode, you will have to cancel the teletext first by pressing / to return to a normal TV picture.

To select the time display:

If you press / while watching a normal TV broadcast, you will see a time display from the broadcaster. It will remain on the screen for about 5 seconds.

9:56 and 25 seconds p.m.

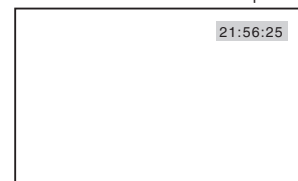

Note:

If you press  while this mode is activated, this mode will be cancelled.

Connecting your TV

Side connections

You can connect a wide variety of auxiliary equipment via the terminals located on the right side of the panel \odot (2).

Please always refer to the owner's manual of the equipment to be connected for full details.

Connection example

TV right side view

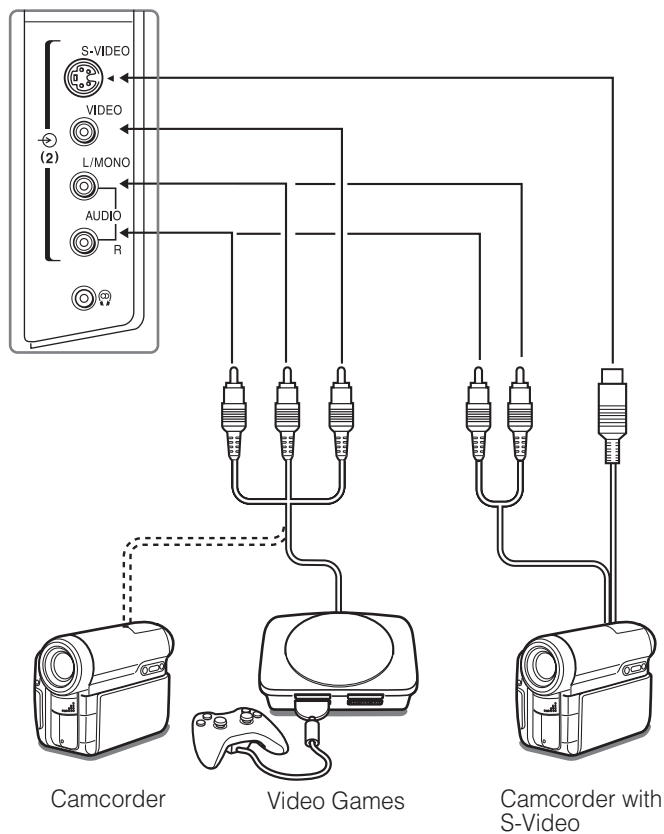

- To select the side inputs, press and hold \odot until the video input mode list appears on the screen, then press ∇ or \blacktriangle to select \odot 2 (see page 21), then press OK .
- Before connecting any external equipment, turn off all main power switches.
- If you connect both of the **S-VIDEO** input terminal and **VIDEO** input terminal, the **S-VIDEO** signal will appear on the screen (display changes to \odot 2S).
- If you connect mono sound equipment to \odot (2), connect the audio output of the equipment to the **L/MONO** jack on the TV.
- You can enjoy Video Games with this TV. However shooting games, where the player shoots at a target on the TV screen with a light gun, may not work because of the LCD Color TV properties.

Back connections

Connection example

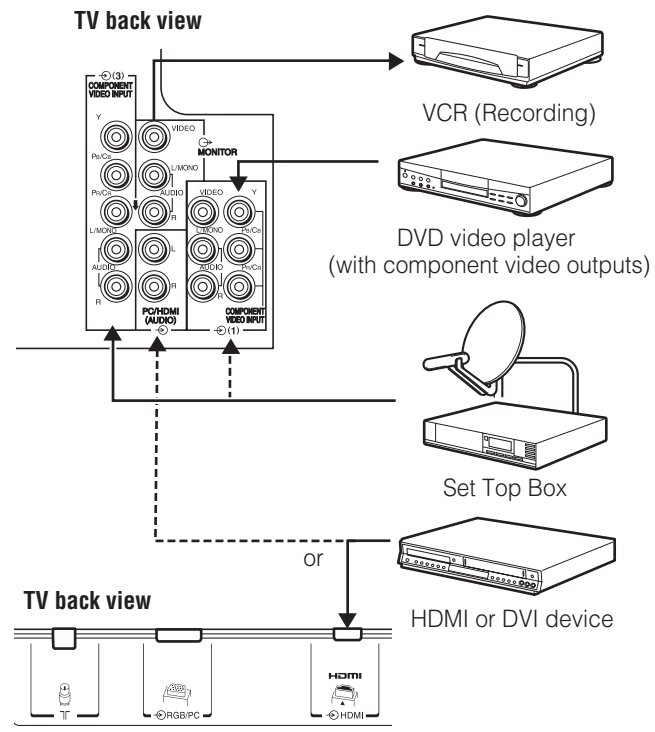

- Before connecting any external equipment, turn off all main power switches.
- The unauthorized recording of television programs, DVDs, video tapes and other materials may infringe upon the provisions of copyright law.
- If you connect both of the **COMPONENT VIDEO INPUT** terminal and **VIDEO** input terminal, the **COMPONENT VIDEO** signal will appear on the screen (display changes to \odot 1C).
- The **COMPONENT VIDEO INPUT** consists of three component video signals (**Y**, **P_B/C_B**, **P_R/C_R**) and provides the best picture performance. These terminals can only be used with the component video compatible equipment e.g. DVD video player, etc.
- Additional equipment and cables shown are not supplied with this TV.

Connecting your TV

Connecting an HDMI or a DVI device

- This TV is not intended for connection to and should not be used with a PC.
- When turning on your electronic components, turn on the TV first, and then the HDMI or DVI device.
- When turning off your electronic components, turn off the HDMI or DVI device first, and then the TV.
- This TV may not be compatible with features and/or specifications that may be added in the future.
- This TV is only operable with L-PCM on 32/44. 1/48 kHz and 16/20/24 bits. If there is no sound when using HDMI, use the analog audio cables to connect the TV and the HDMI device, and select **Analog** in **HDMI audio** of the **AV connection** menu (see page 26).

Connecting an HDMI or a DVI device

The HDMI input on your TV receives digital audio and uncompressed digital video from an HDMI device or uncompressed digital video from a DVI device.

This input is designed to accept HDCP program material in digital from EIA/CEA-861/861B compliant consumer electronic devices (such as a set top box or DVD player with HDMI or DVI output).

The HDMI input is designed for best performance with 1080i (50 Hz/60 Hz) high-definition video signals, but will also accept and display 480i, 480p, 576i, 576p, 720p (50 Hz/60 Hz (60Hz: except for the E-EDID)) and VGA signals.

- HDMI: High-Definition Multimedia Interface
- DVI: Digital Video Interface
- HDCP: High-bandwidth Digital Content Protection
- EIA/CEA-861/861B compliance covers the transmission of uncompressed digital video with high-bandwidth digital content protection, which is being standardized for reception of high-definition video signals. Because this is an evolving technology, it is possible that some devices may not operate properly with the TV.
- E-EDID: Enhanced-Extended Display Identification
- VGA: VESA 640 × 480 @ 60 Hz
- L-PCM: Linear-Pulse Code Modulation

Connecting an HDMI device

One HDMI cable (type A connector)

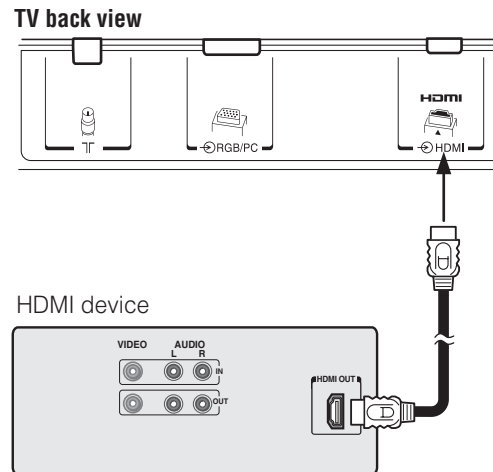

For proper operation, it is recommended that you use a short HDMI cable.

HDMI cable transfers both video and audio.

Connecting a DVI device

One HDMI (type A connector)-to-DVI adapter cable and audio cables

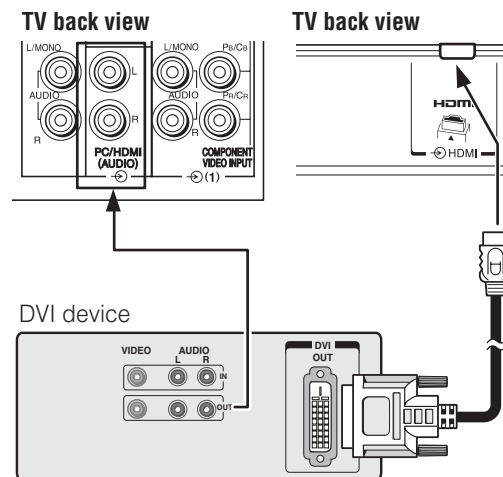

HDMI (type A connector)-to-DVI adapter cable

For proper operation, the length of an HDMI-to-DVI adapter cable should not exceed 3m. The recommended length is 2m.

Standard analog audio cables

An HDMI-to-DVI adapter cable transfers only video. Separate analog audio cables are required.

Note:

HDMI, the HDMI logo, and High-Definition Multimedia Interface are trademarks or registered trademarks of HDMI Licensing, LLC.

Connecting your TV

Selecting the PC/HDMI audio mode

You can select PC audio or HDMI audio when using this function (➤ page 25).

- 1 Press **MENU**, then press **<** or **>** to display the **SET UP** menu.
- 2 Press **∨** or **∧** to select **AV connection**, then press **OK** to display the **AV connection** menu.

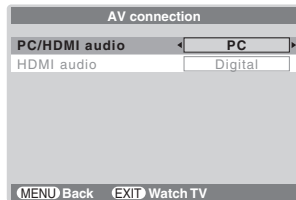

- 3 Press **∨** or **∧** to select **PC/HDMI audio**, then press **<** or **>** to select **PC** or **HDMI**.

Setting the HDMI audio mode

You can select sound of an HDMI or DVI device connected to the HDMI input terminals (➤ page 25) from three modes: **Auto**, **Digital** or **Analog**.

Note:

This function is available only when the PC/HDMI audio mode is set to **HDMI**.

- 1 From the **AV connection** menu, press **∨** or **∧** to select **HDMI audio**.

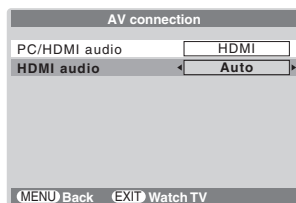

- 2 Press **<** or **>** to select **Auto**, **Digital** or **Analog**.

Connecting a computer

An analog RGB (15 pin) computer cable can be connected.

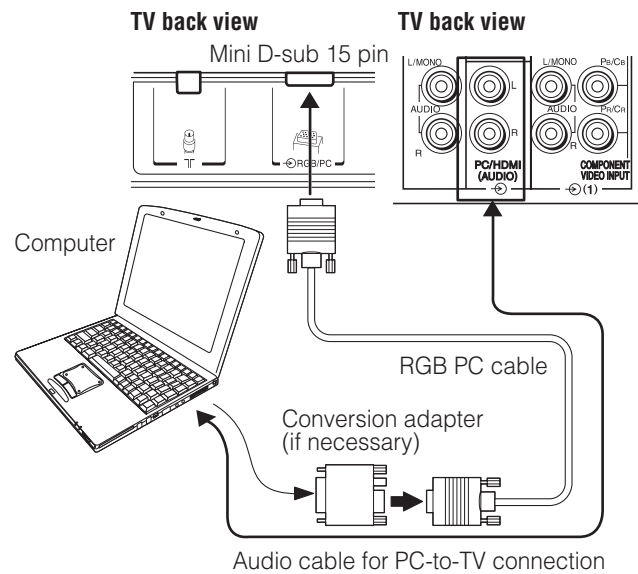

Audio cable for PC-to-TV connection

Connect a PC cable from the computer to the **RGB/PC** terminal on the back of the TV.

The following signals can be displayed:

- VGA: VESA 640 × 480 @ 60 Hz
- SVGA: VESA 800 × 600 @ 60 Hz
- XGA: VESA 1024 × 768 @ 60 Hz
- S-XGA: VESA 1280 × 1024 @ 60 Hz

However, these signal formats are converted to match the number of pixels of the LCD panel.

Therefore, the TV may not display small text properly.

If you connect this unit to your PC, the compressed image is displayed in S-XGA mode, therefore the picture quality may deteriorate and characters may not be read.

Notes:

- Some PC models cannot be connected to this TV.
- There is no need to use an adapter for computers with DOS/V compatible mini D-sub 15 pin terminal.
- A bar may appear in the upper, lower, right or left side of the screen, or parts of the picture may be obscured depending on some signals. This is not the malfunction.
- If the edges of the picture are stretched, readjust the picture position adjustments in the **PC Setting** menu.
- Depending on the specification of the PC you are playing the DVD-Video on, and the DVD's title, some scenes may be skipped, or you may not be able to pause during multi-angle scenes.

Connecting your TV

Signal names for mini D-sub 15 pin connector

Pin assignment for RGB/PC terminal

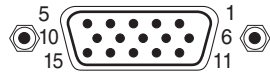

| Pin No. | Signal name | Pin No. | Signal name |
|---------|--------------------|---------|-------------|
| 1 | R | 9 | NC |
| 2 | G | 10 | Ground |
| 3 | B | 11 | NC |
| 4 | NC (not connected) | 12 | NC |
| 5 | NC | 13 | H-sync |
| 6 | Ground | 14 | V-sync |
| 7 | Ground | 15 | NC |
| 8 | Ground | | |

Using the PC setting

- In the PC input mode, you cannot select the **Color**, **Tint**, **Sharpness**, **Black stretch**, **MPEG NR** and **DNR** in the **Picture setting** menu and **Cinema mode** (page 18).
- In the PC input mode, the **Manual setting** (page 21) is not displayed.
- First press and hold until the video input mode list appears on the screen, then press \downarrow or \uparrow and OK in order to select the PC input mode (page 21).
- This function may not be available for some signal or if no signal is received.
- The optimum points of the clock phase and sampling clock adjustments may be incomprehensible according to the input signals.

Adjusting the picture size/position

- Press MENU , then press \leftarrow or \rightarrow to display the **SET UP** menu.
- Press \downarrow or \uparrow to select **PC Setting**.

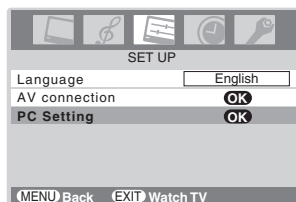

- Press OK to display the **PC Setting** menu.

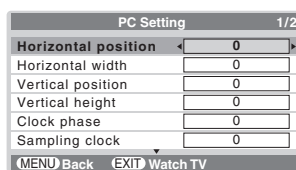

- Press \downarrow or \uparrow to select an option you want to adjust. Press \leftarrow or \rightarrow to adjust the settings as required.



Adjusting the clock phase of the picture

If the clock phase, which synchronizes the PC signal and LCD display, is not optimized, the picture will blur.

This function enables you to adjust clock phase and display a clear picture.

- From the **PC Setting** menu, press \downarrow or \uparrow to select **Clock phase**.
- Press \leftarrow or \rightarrow to obtain a clear picture.



Adjusting the sampling clock

If the sampling clock does not match with the dot clock frequency of the PC, blurred picture detail will occur, or screen width will change, or drift patterns in vertical lines may be apparent.

This function enables you to adjust it and optimize the picture.

- From the **PC Setting** menu, press \downarrow or \uparrow to select **Sampling clock**.
- Press \leftarrow or \rightarrow to optimize the picture.



Resetting the PC setting

The Reset function adjusts the PC Setting to the factory settings.

- From the **PC Setting** menu, press \downarrow or \uparrow to select **Reset** on the 2nd page.

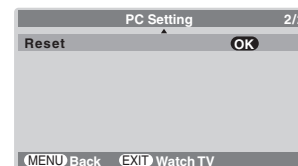

- Press OK .

Reference section

Troubleshooting

Before calling a service technician, please check the following table for a possible cause of the symptom and some solutions.

Symptom and solution

TV will not turn on

- Make sure the power cord is plugged in, then press $\odot/1$ and \odot .
- The remote control batteries may be dead. Replace the batteries.

No picture, no sound

- Check the antenna connections.

No sound, picture OK

- The sound may be muted. Press $\triangle+$, $\triangle-$ or \otimes .
- The station may have broadcast difficulties. Try another channel.

Poor sound, picture OK

- The station may have broadcast difficulties. Try another channel.

Poor picture, sound OK

- Check the antenna connections.
- The station may have broadcast difficulties. Try another channel.
- Adjust the **PICTURE** menu.

Poor reception of broadcast channels

- Check the antenna connections.
- The station may have broadcast difficulties. Try another channel.
- Make sure the Color system is properly set.

Teletext problems

- Check the antenna connections.
Good performance of text depends on a good strong broadcast signal.

Multiple images

- The station may have broadcast difficulties. Try another channel.
- Antenna reception may be poor. Use a high directional outdoor antenna.
- Check if the direction of the antenna has changed.

Poor color or no color

- The station may have broadcast difficulties. Try another channel.
- Adjust the **Tint** and/or **Color** in the **PICTURE** menu.

The remote control does not operate

- Remove all obstructions between the remote control and the remote control sensor on the TV.
- The remote control batteries may be dead. Replace them with new ones.

Some pixels of the screen do not light up

- The LCD display panel is manufactured using an extremely high level of precision technology, however, sometimes some pixels of the screen may be missing picture elements or have luminous spots. This is not a sign of a malfunction.

The brightness of the screen comes down, or flickers of the screen are caused, or some parts of the screen do not light up.

- When you just buy and start to use this TV, a flickering may be caused in the screen. In this case, switch off the TV, then switch on it again to cure the condition.
- The cold cathode fluorescent lamp used for the back light on this TV has longevity. When the brightness of the screen comes down, or the flickers of the screen are caused, or some parts of the screen do not light up, it may reach the end of its life. Contact a service technician.

The picture brightness varies when you display switch the TV on.

- If you switch the TV on at 0°C and under, wait until the warms up.

Broadcast system

Broadcast transmission systems of each country or region

Asia M.E.

| Country or region | Color | Sound |
|--|-------|-------|
| Bahrain, Kuwait, Israel, Oman, Qatar, United Arab Emirates, Yemen, etc. Indonesia, Malaysia, Singapore, Thailand, etc. | PAL | B/G |
| China | PAL | D/K |
| China Hong Kong | PAL | I |
| Iraq, Islamic Republic of Iran, Lebanon, Saudi Arabia, etc. | SECAM | B/G |
| Russian Federation, etc. | SECAM | D/K |
| Myanmar, etc. | NTSC | M |

Oceania

| Country or region | Color | Sound |
|------------------------------|-------|-------|
| Australia, New Zealand, etc. | PAL | B/G |

Africa

| Country or region | Color | Sound |
|--------------------------------|-------|-------|
| Republic of South Africa, etc. | PAL | I |

South America

| Country or region | Color | Sound |
|------------------------------------|-------|-------|
| Argentina, Paraguay, Uruguay, etc. | PAL | N |
| Brazil | PAL | M |
| Chile, Colombia, etc. | NTSC | M |

Reference section

Note:

PAL, SECAM and NTSC 3.58 (MHz) are different color signal broadcast transmission systems applicable to different countries or region. NTSC 4.43 (MHz) is used in special VCRs to playback NTSC recorded video tapes through PAL television equipment.

Specifications

LCD color television

Model

26WL66A, 26WL66E, 26WL66T

Power source

26WL66A: 220V-240V AC, 50Hz
26WL66E: 220V-240V AC, 50/60Hz
26WL66T: 110V-240V AC, 50/60Hz

Power consumption

121 W, 0.9 W (standby)

Dimensions

660 mm (W) 535 mm (H) 275 mm (D)

Mass (Weight)

14.5 kg

Television system (Antenna input)

Channel coverage:

| | | | | |
|-------|-----|---------|------|-----------------------------------|
| PAL | B/G | (CCIR) | VHF | 2 - 12 |
| | | | UHF | 21 - 69 |
| | | | CATV | X - Z+2, S1 - S41 |
| PAL | I | (UK) | VHF | - |
| | | | UHF | 21 - 69 |
| | | | CATV | - |
| PAL | D/K | (CHINA) | VHF | 1 - 12 |
| | | | UHF | 13 - 57 |
| | | | CATV | Z1 - Z38 |
| SECAM | B/G | (CCIR) | VHF | 2 - 12 |
| | | | UHF | 21 - 69 |
| | | | CATV | X - Z+2, S1 - S41 |
| SECAM | D/K | (OIRT) | VHF | 1 - 12 |
| | | | UHF | 21 - 69 |
| | | | CATV | X1 - X19 |
| NTSC | M | (US) | VHF | 2 - 13 |
| | | | UHF | 14 - 69 |
| | | | CATV | A6 - A1, A - W, AA - ZZ, AAA, BBB |
| NTSC | M | (JAPAN) | VHF | 1 - 12 |
| | | | UHF | 13 - 62 |
| | | | CATV | M1 - M10, S1 - S41 |

Special RF signal:

NTSC 4.43 color system 5.5/6.0/6.5 MHz sound system
PAL 60 Hz color system 5.5/6.0/6.5 MHz sound system

COMPONENT VIDEO INPUT terminals (the signal format)

480i, 480p, 576i, 576p, 720p (50/60 Hz), 1080i (50/60 Hz)
(These signal formats are converted to match the number of pixels of the LCD panel.)

Color system

PAL, SECAM, NTSC 3.58/4.43

Aspect ratio

16 : 9

Visible size (diagonal)

66.1 cm

Number of pixels

1366 (H) dots × 768 (V) dots

Audio power

10 W + 10 W (10% THD)

Speakers

Main 60 × 120 mm 2pcs.

Input/Output terminals

| | | |
|-------------------|----------------|---------------------------------|
| ⊖ (1) | Input | Component video Y, Pb/Cb, Pr/Cr |
| | Phono jacks | A/V |
| ⊖ (2) | Input | 4 pin S-video |
| | Phono jacks | A/V |
| ⊖ (3) | Input | Component video Y, Pb/Cb, Pr/Cr |
| | Phono jacks | Audio L/Mono + R |
| ↪ MONITOR | Output | Phono jacks A/V |
| ⊖ RGB/PC | Input | Mini D-sub 15 pin Analog RGB |
| ⊖ PC/HDMI (AUDIO) | Input | Phono jacks Audio L+R |
| ⊖ HDMI | Input (type A) | 19 pin A/V Digital |
| ⊖ PC/HDMI (AUDIO) | Input | Phono jacks Analog L+R |
| | Headphone jack | 3.5 mm (Diameter) stereo |

Operating condition

Temperature 0°C - 35°C
Humidity 20% - 80% (No moisture condensation)

Supplied accessories

Owner's manual (1), Remote control (1), Batteries (2), Clip (1)



This is used to fix the TV to a wall, pillar, etc. (see page 4).

- Design and specifications are subject to change without notice.
- Never service or remodel the TV by yourself. It may expose you to a fire hazard or dangerous voltages.

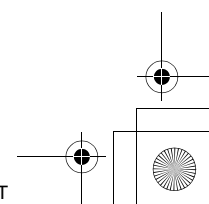
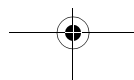
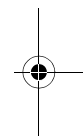
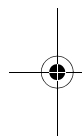
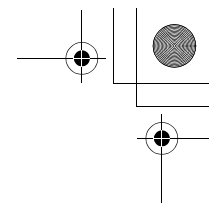
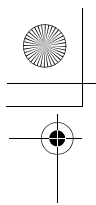

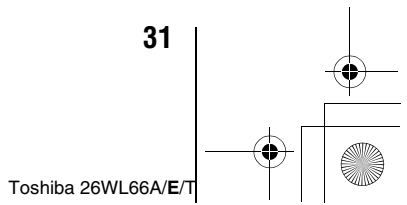
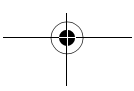
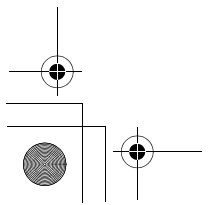
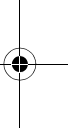
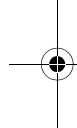
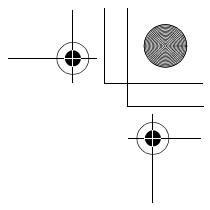
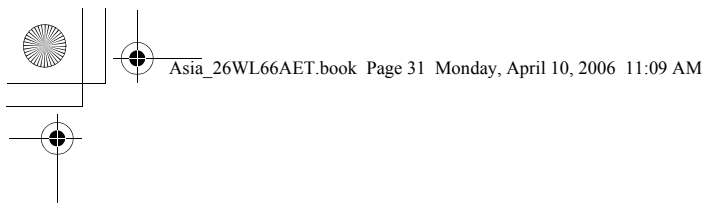

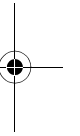
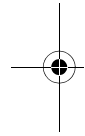
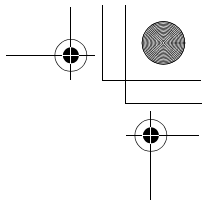
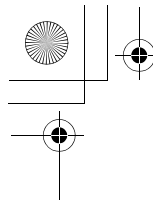

TOSHIBA CORPORATION

